

Owner's Manual

36" Built-In
All-Refrigerators and
All-Freezers

Contents

Consumer Services

Important Phone Numbers 19
Model and Serial Numbers 3
Problem Solver 16-17
Product Registration 3
Safety Instructions 4-7
State of California
Warranty Back Cover

Care and Cleaning

Cleaning—Outside and Inside 13
Light Bulb Replacement 14
Vacation 14

Operating Instructions

Automatic Icemaker 9
Sabbath Mode Product 13
Shelves 12
Storage Drawers 11
Temperature Controls 8
Water Filter Accessory 10

Preparation

Location 15

*Before
using
your
refrigerator/
freezer*

Read this manual carefully. It is intended to help you operate and maintain your new refrigerator/freezer properly.

Keep it handy for answers to your questions.

If you don't understand something or need more help, there is a list of toll-free consumer service numbers included in the back section of this manual.

OR

Visit our Website at: monogram.com

Write down the model & serial numbers

You'll see them on a label inside the refrigerator/freezer under the storage drawers.

Before sending in the Product Registration card, please write these numbers here:

Model Number

Serial Number

Use these numbers in any correspondence or service calls concerning your refrigerator/freezer.

If you received a damaged refrigerator/freezer

Immediately contact the dealer (or builder) that sold you the refrigerator/freezer.

Save time & money

Before you request service, check the Problem Solver in the back of this manual.

It lists causes of minor operating problems that you can correct yourself.

If you need service

To obtain service, see the Consumer Services page in the back of this manual.

We're proud of our service and want you to be pleased. If for some reason you are not happy with the service you receive, here are steps to follow for further help.

For customers in the USA:

FIRST, contact the people who serviced your appliance. Explain why you are not pleased. In most cases, this will solve the problem.

NEXT, if you are still not pleased, write all the details—including your phone number—to:

Manager, Customer Relations
GE Appliances
Appliance Park
Louisville, KY 40225

For customers in Canada:

FIRST, contact the people who serviced your appliance. Explain why you are not pleased. In most cases, this will solve the problem.

NEXT, if you are still not pleased, write all the details—including your phone number to:

Manager, Consumer Relations
Mabe Canada Inc.
1 Factory Lane, Suite 310
Moncton, N.B. E1C 9M3

IMPORTANT SAFETY INSTRUCTIONS



GE Appliances Website

For more information on your refrigerator's operation, visit www.GEAppliances.com or call 800.GECARES (800.432.2737). In Canada visit GEAppliances.ca or call 800.561.3344.

REFRIGERATOR/FREEZER SAFETY INFORMATION

! This is the safety alert symbol. This symbol alerts you to potential hazards that can kill or hurt you and others. All safety messages will follow the safety alert symbol and the word "DANGER", "WARNING", or "CAUTION". These words are defined as:

! DANGER Indicates a hazardous situation which, if not avoided, **will** result in death or serious injury.

! WARNING Indicates a hazardous situation which, if not avoided, **could** result in death or serious injury.

! CAUTION Indicates a hazardous situation which, if not avoided, **could** result in minor or moderate injury.

IMPORTANT SAFETY INSTRUCTIONS

! WARNING To reduce the risk of fire, explosion, electric shock, or injury when using your refrigerator/freezer follow these basic safety precautions:

- This refrigerator/freezer must be properly installed and located in accordance with the Installation Instructions before it is used.
 - Replace all parts and panels before operating.
 - Do not store or use gasoline or other flammable vapors and liquids in the vicinity of this or any other appliance.
 - Because of potential safety hazards under certain conditions, we strongly recommend against the use of an extension cord. However, if you must use an extension cord, it is absolutely necessary that it be a UL-listed (in the United States) or a CSA certified (in Canada), 3-wire grounding type appliance extension cord having a grounding type plug and outlet and that the electrical rating of the cord be 15 amperes (minimum) and 120 volts.
 - To prevent suffocation and entrapment hazards to children, remove the doors from any refrigerator/freezer before disposing of it or discontinuing its use.
 - Do not allow children to climb, stand or hang on the door handles or the shelves in the refrigerator/freezer. They could seriously injure themselves.
 - Unplug the refrigerator/freezer :
 - To discontinue power to the refrigerator/freezer. It cannot be turned off by any setting on the control panel.
 - To clean, replace a burned out light bulb, or make repairs.
- Note:** Repairs must be performed by a qualified Service Professional.

State of California Proposition 65 Warnings:

! WARNING This product contains one or more chemicals known to the State of California to cause cancer and birth defects or other reproductive harm.

! CAUTION To reduce the risk of injury when using your refrigerator/freezer, follow these basic precautions.

- In refrigerators/freezers with automatic icemakers, avoid contact with the moving parts of the ejector mechanism, or with the heating element that releases the cubes. Do not place fingers or hands on the automatic ice making mechanism while the refrigerator is plugged in.
- Do not clean glass shelves or covers with warm water when they are cold. Glass shelves and covers may break if exposed to sudden temperature changes or impact, such as bumping or dropping. Tempered glass is designed to shatter into many small pieces if it breaks.
- Keep fingers out of the "pinch point" areas; clearances between the doors and between the doors and cabinet are necessarily small. Be careful closing doors when children are in the area.
- Do not touch the cold surfaces in the freezer compartment when hands are damp or wet, skin may stick to these extremely cold surfaces.
- Do not refreeze frozen foods which have thawed completely.

IMPORTANT SAFETY INSTRUCTIONS



Site Internet d'Électroménagers GE

Pour de plus amples informations sur le fonctionnement de votre réfrigérateur, consultez le site www.electromenagers.ge.ca ou composez le 800.561.3344.

CONSIGNES DE SÉCURITÉ POUR LE RÉFRIGÉRATEUR / CONGÉLATEUR

! Ce symbole représente une alerte de sécurité. Ce symbole vous avise de dangers possibles pouvant causer la mort, des blessures ou autres. Tous les messages de sécurité seront précédés du symbole d'alerte de sécurité ainsi que des mots « DANGER », « AVERTISSEMENT » ou « MISE EN GARDE ». Ces messages sont les suivants :

! DANGER Signale une situation qui présente un danger imminent et qui, si elle n'est pas évitée, entraînera des blessures graves, voire la mort.

! AVERTISSEMENT Signale une situation qui présente un danger imminent et qui, si elle n'est pas évitée, peut entraîner des blessures graves, voire la mort.

! ATTENTION Signale une situation qui présente un danger imminent et qui, si elle n'est pas évitée, peut entraîner des blessures mineures ou graves.

IMPORTANTES CONSIGNES DE SÉCURITÉ

! AVERTISSEMENT Pour réduire le risque d'incendie, d'explosion, de choc électrique ou de blessures lorsque vous utilisez votre réfrigérateur / congélateur, veuillez suivre ces consignes de sécurité :

- Vous devez bien installer et placer votre réfrigérateur / congélateur, conformément aux Instructions d'installation avant de l'utiliser.
 - Remettez toutes les pièces et panneaux en place avant d'utiliser l'appareil.
 - Ne conservez jamais ou n'utilisez jamais d'essence ou d'autres liquides ou gaz inflammables à proximité de votre réfrigérateur ou de tout autre appareil électroménager.
 - Nous déconseillons fortement l'utilisation d'une rallonge à cause des risques potentiels dans certaines conditions. Cependant, si l'utilisation d'un cordon prolongateur est nécessaire, ce dernier doit obligatoirement être homologué UL (aux USA) ou CSA (au Canada), à trois brins avec mise à la terre pour appareil électroménager et doit être équipé d'une fiche et d'une prise femelle avec terre. Les caractéristiques électriques du cordon prolongateur doivent être de 15 ampères (minimum) et de 120 volts.
 - Pour éviter les risques d'asphyxie et d'enfermement pour les enfants. Démontez les portes de réfrigérateur / congélateur avant de le mettre au rebut ou d'interrompre son utilisation.
 - Ne permettez jamais aux enfants de grimper, de monter, de se tenir ou de se pendre aux étagères de votre réfrigérateur. Ils peuvent endommager le réfrigérateur et se blesser sérieusement.
 - Débranchez votre réfrigérateur / congélateur :
 - L'alimentation électrique du réfrigérateur ne peut pas être coupée par l'intermédiaire du panneau de commande.
 - Débranchez votre réfrigérateur avant de le nettoyer, Avant de remplacer une ampoule grillée, et de le réparer.
- NOTE :** Nous vous recommandons fortement de faire accomplir tout service par un technicien qualifié.

Avertissements de la Proposition 65 de l'État de la Californie :

! AVERTISSEMENT Ce produit contient une ou plusieurs substances chimiques reconnues par l'État de Californie pour causer le cancer et des anomalies congénitales ou d'autres problèmes liés à la reproduction.

! ATTENTION Pour réduire le risque de blessures lorsque vous utilisez votre réfrigérateur, veuillez suivre ces consignes de sécurité :

- Dans les réfrigérateurs / congélateurs qui ont des machines à glaçons, évitez tout contact avec les éléments mobiles du mécanisme d'éjection ou avec l'élément chauffant situé à la partie inférieure de la machine à glaçons. Ne mettez jamais vos doigts ou vos mains sur le mécanisme de fabrication automatique de glaçons quand le réfrigérateur est branché.
- Ne nettoyez pas les clayettes ou les couvercles en verre avec de l'eau tiède quand ceux-ci sont froids. Les clayettes et couvercles en verre peuvent se casser s'ils sont exposés à des changements soudains de température ou si vous les cognez ou les faites tomber. Le verre trempé est conçu pour se briser en petits morceaux en cas de casse.
- Ne laissez jamais vos doigts dans des endroits où ils risquent d'être pincés. L'écartement entre les portes et l'armoire est nécessairement petit. Faites attention de fermer les portes quand des enfants se trouvent à proximité.
- Ne touchez jamais les surfaces froides dans le compartiment congélation quand vos mains sont humides ou mouillées. Votre peau peut coller à ces surfaces extrêmement froides.
- Ne recongelez pas les aliments surgelés qui ont complètement dégelé.

IMPORTANT SAFETY INSTRUCTIONS

INSTALLATION



WARNING Explosion Hazard.

Keep flammable materials and vapors, such as gasoline, away from freezer. Failure to do so can result in fire, explosion, or death.

CONNECTING ELECTRICITY



WARNING Electrical Shock Hazard.

Plug into a grounded 3-prong outlet
Do not remove the ground prong
Do not use an adapter

Failure to follow these instructions can result in death, fire, or electrical shock.

Do not, under any circumstances, cut or remove the third (ground) prong from the power cord. For personal safety, this appliance must be properly grounded.

The power cord of this appliance is equipped with a 3-prong (grounding) plug which mates with a standard 3-prong (grounding) wall outlet to minimize the possibility of electric shock hazard from this appliance.

Have the wall outlet and circuit checked by a qualified electrician to make sure the outlet is properly grounded.

Where a standard 2-prong wall outlet is encountered, it is your personal responsibility and obligation to have it replaced with a properly grounded 3-prong wall outlet. Do not use an adapter.

The refrigerator/freezer should always be plugged into its own individual electrical outlet which has a voltage rating that matches the rating plate. This provides the best performance and also prevents overloading house wiring circuits which could cause a fire hazard from overheated wires.

Never unplug your refrigerator/freezer by pulling on the power cord. Always grip plug firmly and pull straight out from the outlet.

Repair or replace immediately all power cords that have become frayed or otherwise damaged. Do not use a cord that shows cracks or abrasion damage along its length or at either end.

When moving the refrigerator/freezer away from the wall, be careful not to roll over or damage the power cord.

USE OF EXTENSION CORDS

Because of potential safety hazards under certain conditions, we strongly recommend against the use of an extension cord.

However, if you must use an extension cord, it is absolutely necessary that it be a UL-listed (in the United States) or a CSA-listed (in Canada), 3-wire grounding type appliance extension cord having a grounding type plug and outlet and that the electrical rating of the cord be 15 amperes (minimum) and 120 volts.

PROPER DISPOSAL OF YOUR OLD REFRIGERATOR



WARNING Suffocation and child entrapment hazard.

Remove fresh-food or freezer doors prior to disposal. Failure to do so can result in child entrapment which can lead to death or brain damage.

IMPORTANT:

Child entrapment and suffocation are not problems of the past. Junked or abandoned refrigerators are still dangerous even if they will sit for "just a few days." If you are getting rid of your old refrigerator, please follow the instructions below to help prevent accidents.

Before You Throw Away Your Old Refrigerator or Freezer:

- Take off the fresh food and freezer doors.

- Leave the shelves in place so that children may not easily climb inside.

Refrigerants

All refrigeration products contain refrigerants, which under federal law must be removed prior to product disposal. If you are getting rid of an old refrigeration product, check with the company handling the disposal about what to do.



**READ AND FOLLOW THIS SAFETY INFORMATION CAREFULLY.
SAVE THESE INSTRUCTIONS**

IMPORTANT SAFETY INSTRUCTIONS

INSTALLATION



Risque d'explosion.

Conservez les matériaux et vapeurs inflammables tels que l'essence à l'écart de votre congélateur. Une explosion, un incendie voire la mort pourrait en résulter.

BRANCHEMENTS ÉLECTRIQUES



Risque de choc électrique.

Branchez l'appareil dans une prise triple avec terre.
Ne retirez pas la broche de terre.
N'utilisez pas d'adaptateur.

Le non-respect de ces instructions peut entraîner des risques d'incendies, des chocs électriques ou la mort.

Ne coupez pas ou n'enlevez pas, sous aucun prétexte, la troisième broche de mise à la terre du cordon d'alimentation. Pour des raisons de sécurité, cet appareil doit être correctement mis à la terre.

Le cordon d'alimentation de cet appareil est équipé d'une fiche à trois broches (pour une mise à la terre) qui s'adapte à la prise de courant standard à 3 broches (pour une mise à la terre) pour minimiser les risques de chocs électriques par cet appareil.

Faites vérifier la prise murale et le circuit électrique par un électricien qualifié pour s'assurer que le système est correctement mis à la terre.

Dans le cas d'une prise biphasée, l'installateur a la responsabilité et l'obligation de la remplacer par une prise triphasée correctement mise à la terre. N'utilisez pas d'adaptateur.

Le réfrigérateur / congélateur doit toujours être branché à sa propre prise électrique d'une tension nominale correspondant à celle indiquée sur sa plaque signalétique.

Une alimentation électrique à 115 volts CA, 60 Hz, avec un fusible de

15 ou 20 ampères et une mise à la terre est nécessaire. Ceci permet d'obtenir un meilleur rendement et évite de surcharger les circuits électriques du domicile qui risque d'occasionner un incendie en surchauffant.

Ne débranchez jamais le réfrigérateur / congélateur en tirant sur le cordon d'alimentation. Prenez toujours fermement la fiche en main et tirez pour la sortir de la prise.

Réparez ou remplacez immédiatement tout cordon électrique usé ou endommagé. N'utilisez pas un cordon fissuré ou présentant des dommages dus aux frottements soit sur sa longueur ou aux extrémités.

Lorsque vous éloignez votre réfrigérateur / congélateur du mur, faites attention à ne pas le faire rouler sur le cordon d'alimentation afin de ne pas l'endommager.

UTILISATION DE RALLONGES ÉLECTRIQUES

Nous vous recommandons fortement de ne pas utiliser de rallonge électrique, à cause d'un danger de risques possibles de sécurité dans certaines conditions.

Cependant, si vous devez absolument utiliser un cordon rallonge électrique, il est absolument requis que vous utilisiez un cordon rallonge trifilaire, avec mise à la terre, certifié UL (aux États-Unis) ou ACNOR (au Canada), avec prise et fiche à trois conducteurs, et à notation électrique de 15 ampères (minimum) et 120 volts.

MISE AU REBUT APPROPRIÉE DE VOTRE ANCIEN RÉFRIGÉRATEUR



Un enfant risque de suffoquer ou d'y être emprisonné.

Démontez les portes du compartiment de réfrigération ou du compartiment de congélation, avant mettre celui-ci au rebut. Le non-respect de cette recommandation peut entraîner l'enfermement d'un enfant qui peut entraîner la mort ou des lésions cérébrales.

IMPORTANT:

Les enfants pris au piège ou morts d'asphyxie sont toujours d'actualité. Les réfrigérateurs jetés ou abandonnés restent dangereux même si vous ne les laissez au rebut que pour « quelques jours ». Si vous voulez jeter votre ancien réfrigérateur, suivez les instructions suivantes pour empêcher les accidents.

Avant de jeter votre ancien réfrigérateur ou congélateur:

- Démontez les portes du compartiment de réfrigération ou du compartiment de congélation.
- Laissez les clayettes en place, pour éviter que des enfants puissent facilement grimper dans votre réfrigérateur.

Fluides frigorigènes

Les appareils réfrigérants contiennent des fluides frigorigènes qui conformément à la législation fédérale doivent être retirés avant la mise au rebut de l'appareil. Si vous mettez au rebut un ancien réfrigérateur contenant des fluides frigorigènes, vérifiez la procédure à suivre auprès de la compagnie responsable de l'élimination.



**LISEZ ET SUIVEZ SOIGNEUSEMENT CES MESURES DE SÉCURITÉ.
CONSERVEZ CES INSTRUCTIONS**

All-Freezer Controls



Preset Settings: Allow 24 hours to reach these preset temperatures.

All-Refrigerator Controls



Preset Settings: Allow 24 hours to reach these preset temperatures.

Temperature controls

The temperature display shows the actual temperature of the freezer or fresh food unit. The actual temperature will vary from the set temperature based on factors such as door opening, amount of food, defrost cycling and room temperature.

NOTE: Frequent door openings or door left open for periods of time may increase the internal temperature of the freezer and fresh food compartments temporarily.

To turn off the cooling system in either the freezer or fresh food unit, press the plus (+) pad until the display shows OFF.

To turn the cooling system on, press the minus (-) pad. The preset temperature of 0°F for the freezer or 37°F for the fresh food unit will appear in the display.

To check the current temperature setting for the fresh food or freezer unit, press the plus (+) or minus (-) pad once. After 5 seconds, the display will return to the actual temperature.

To change the temperature settings, press the plus (+) or minus (-) pad for each increment to the desired temperature set point. Allow 24 hours for the unit to reach the temperature you have set.

Temperature Ranges

	Low	High
Fresh Food	34°F 1°C	42°F 5°C
Freezer	-6°F -21°C	+4°F -15°C

NOTE: Setting the controls to **OFF** stops cooling, but **does not** shut off electrical power to the unit.

Changing display temperatures from °F to °C

To change the temperature display between Fahrenheit and Celsius, press **Temp Display °C/°F**.

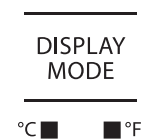

Door alarm

To turn the Door Alarm feature on, press **DOOR ALARM** once. The **ACTIVE** light will come on. To turn it off, press it again.

When the **DOOR ALARM** is active, the alarm will flash and beep if you keep the door open for more than 2 minutes.



Automatic icemaker (freezer models)

CAUTION Avoid contact with the moving parts of the ejector mechanism, or with the heating element (located on the bottom of the icemaker) that releases the cubes. Do not place fingers or hands on the automatic ice making mechanism while the refrigerator is plugged in.

ATTENTION Évitez tout contact avec les pièces mobiles du mécanisme d'éjection ou l'élément chauffant (situé dans le bas de la machine à glaçons) qui libère les cubes. Ne placez pas les doigts ou les mains sur le mécanisme de production de glace automatique lorsque le réfrigérateur est branché dans la prise électrique.

A newly-installed refrigerator may take 12–24 hours to begin making ice.

The icemaker will produce seven cubes per cycle—approximately 15 cycles in a 24-hour period, depending on freezer compartment temperature, room temperature, number of door openings and other use conditions.

If the refrigerator is operated before the water connection is made to the icemaker, set the power switch to **OFF**.

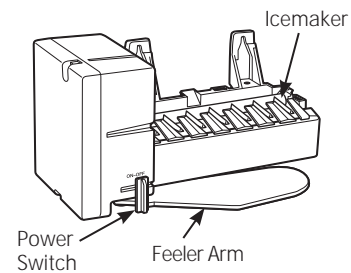

When the refrigerator has been connected to the water supply, set the power switch to **ON**.

Throw away the first full bucket of ice to allow the water line to clear.

Be sure nothing interferes with the sweep of the feeler arm.

When the bin fills to the level of the feeler arm, the icemaker will stop producing ice.

It is normal for several cubes to be joined together.

If ice is not used frequently, old ice cubes will become cloudy, taste stale and shrink.

NOTE: Icemaker works best between 40 and 120 PSI home water pressure.

Accessing the icemaker and ice storage bin (freezer models)

The icemaker is located behind the first drawer on the right of the freezer. The ice bin is the second drawer.

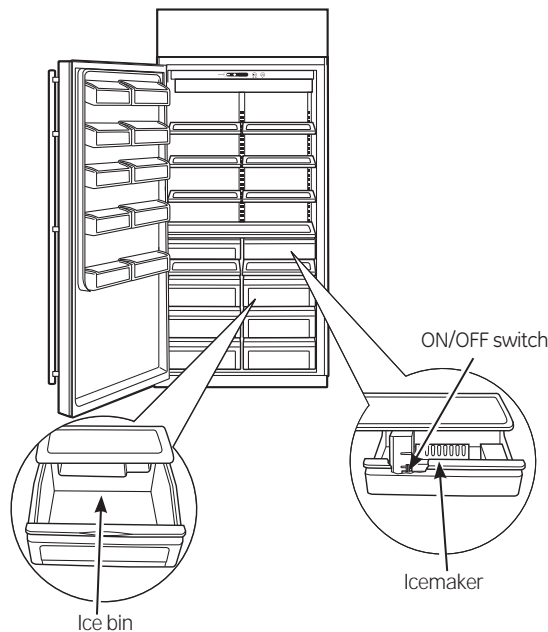

To remove the ice bin:

Open the access door to reach the icemaker. Set the icemaker power switch to the **OFF** position. With the access door closed, support the storage bin at the bottom while slightly lifting. Pull bin straight out. See Drawer Removal section.

To replace the ice bin: Slide the bin back until the tab on the bin locks into the slot on the shelf. After replacing the ice bin, open the access door to reach the icemaker. Set the icemaker power switch to the **ON** position.

Water filter cartridge (freezer models)

Water filter cartridge

The water filter cartridge is located behind the top access panel.

When to replace the filter on models with a replacement indicator light

There is a replacement indicator light for the water filter cartridge on the temperature control panel. This light will turn orange to tell you that you need to replace the filter soon.

The filter cartridge should be replaced when the replacement indicator light turns red or if the flow of water to the icemaker decreases.

Removing the filter cartridge

If you are replacing the cartridge, first remove the old one by slowly turning it to the left. **Do not** pull down on the cartridge. A small amount of water may drip down.

NOTE: To reduce the risk associated with property damage due to water leakage, read and follow instructions before installation and use of this system. Installation and use **MUST** comply with all state and local plumbing codes.

Installing the filter cartridge

- 1 Fill the replacement cartridge with water from the tap to allow for better flow immediately after installation.
- 2 Line up the arrow on the cartridge and the cartridge holder. Place the top of the new cartridge up inside the holder. **Do not** push it up into the holder.
- 3 Slowly turn it to the right until the filter cartridge stops. **DO NOT OVERTIGHTEN.** As you turn the cartridge, it will automatically raise itself into position. The cartridge will move about 1/2 turn.
- 4 Press and hold the **RESET WATER FILTER** pad on the temperature control panel for three seconds to clear the red or amber light.

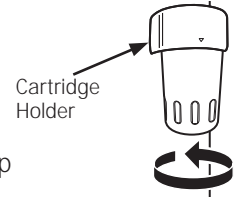

NOTE: A newly installed water filter cartridge may cause water to spurt into the icemaker.

Filter bypass plug

You must use the filter bypass plug when a replacement filter cartridge is not available. The icemaker will not operate without the filter or filter bypass plug.

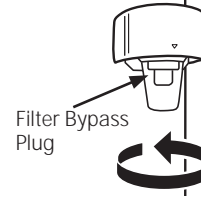

SmartWater

For the maximum benefit of your filtration system, GE Appliances recommends the use of GE Appliances-branded filters only. Using GE Appliances-branded filters in GE Appliances, Hotpoint® and Monogram refrigerators provides optimal performance and reliability. GE Appliances filters meet rigorous industry NSF standards for safety and quality that are important for products that are filtering your water. GE Appliances has not qualified non-GE Appliances-branded filters for use in GE Appliances and Hotpoint refrigerators and there is no assurance that non-GE Appliances-branded filters meet GE Appliances standards for quality, performance and reliability.

If you have questions, or to order additional filter cartridges, visit our website at www.gewaterfilters.com or call GE Appliances Parts and Accessories, 877.959.8688.

Customers in Canada should consult the yellow pages for the nearest Camco Service Center.

Refrigerator— Sealed snack pans

The sealed snack pans retain high humidity for the convenient storage of lunch meats and cheese, hors d'oeuvres, spreads and snacks.

To remove a snack pan, pull the pan out and lift the front of the pan up until it snaps out of the wire holder.

To remove the upper drawers when the door cannot be opened fully, the shelf above the drawers must be removed. Push the shelf back, then lift up. Tilt the cover and take it out.

To replace a snack pan, place the back of the pan in the wire holder. Lower the front of the pan, then push down until the front of the pan snaps into the wire holder.

Excess water that may accumulate in the bottom of the drawers should be emptied and the drawers wiped dry.

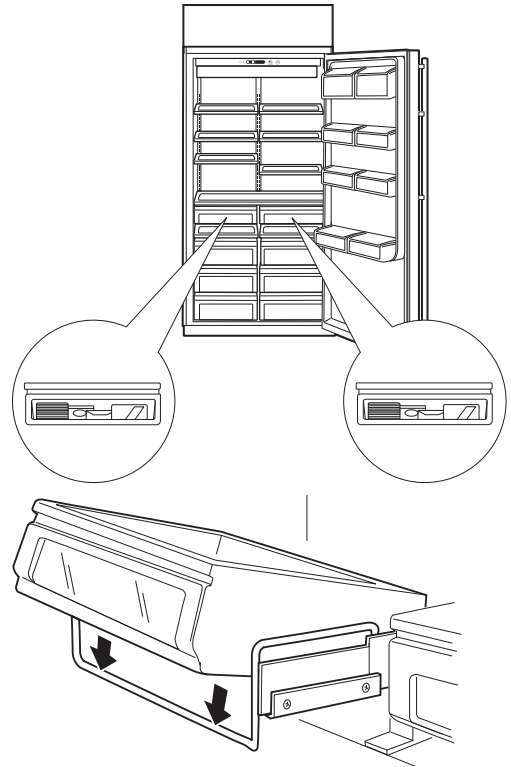

Refrigerator— Storage drawers

The upper drawers have individual, adjustable humidity controls that let you control the amount of cold air entering the drawers.

Slide the control all the way to the High setting and the drawer provides **higher humidity levels** recommended for most leafy vegetables.

Slide the control all the way to the Low setting and the drawer provides **lower humidity levels** recommended for most fruits.

Excess water that may accumulate in the bottom of the drawers should be emptied and the drawers wiped dry.

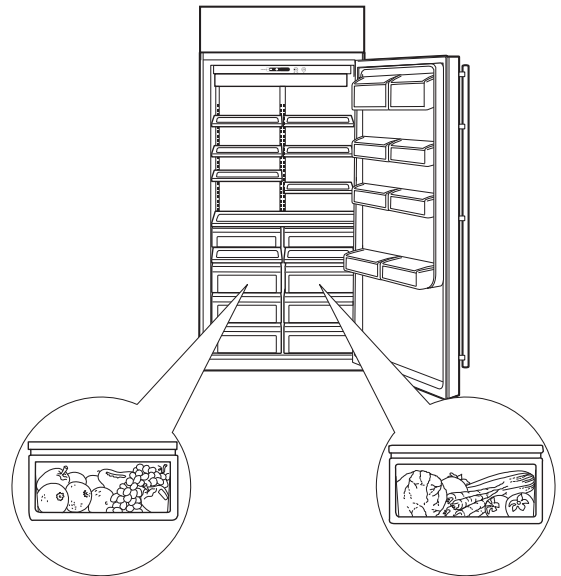

Drawer removal

Drawers in the refrigerator/freezer will stop before coming all the way out, to help prevent contents from spilling onto floor.

To remove a drawer, pull the drawer out and lift the front of the drawer up and out of the wire holder. Lift the back of the drawer up and out.

To replace a drawer, place the back of the drawer in the wire holder, making sure the extensions of the side of the drawer fit into the back of the wire holder. Lower the front of the drawer into the wire holder. Press firmly on the top of the drawer.

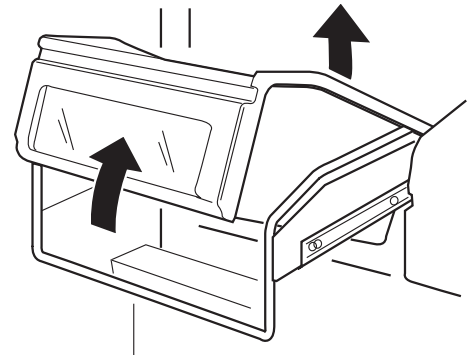

Adjustable shelves

Tempered glass shelves in the refrigerator and wire shelves in the freezer enable you to make efficient shelf arrangements to fit your family's food storage needs.

To remove shelves: Tilt shelf up at front, then lift it up and out of tracks on rear wall of refrigerator/freezer.

Handle glass shelves carefully. Rough handling of tempered glass can cause it to shatter.

To replace shelves: Select desired shelf height. With shelf front raised slightly, engage top lugs in tracks at rear of cabinet. Then lower front of shelf until it locks into position.

CAUTION Do not clean glass shelves or covers with warm water when they are cold. Glass shelves and covers may break if exposed to sudden temperature changes or impact, such as bumping or dropping. Tempered glass is designed to shatter into many small pieces if it breaks.

ATTENTION Ne nettoyez pas les clayettes ou les couvercles en verre avec de l'eau tiède quand ceux-ci sont froids. Les clayettes et couvercles en verre peuvent se casser s'ils sont exposés à des changements soudains de température ou si vous les cognez ou les faites tomber. Le verre trempé est conçu pour se briser en petits morceaux en cas de casse.

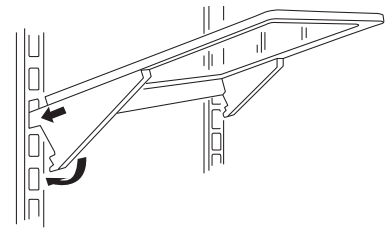
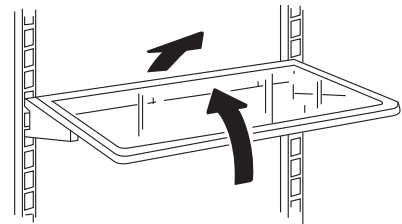

Door shelves

Some door shelves are adjustable and can be moved up and down to meet your storage needs. The deeper door shelves must be placed at the bottom of the door.

To remove: Lift the shelf up and slide it towards you.

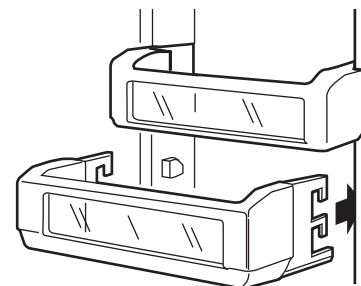

ZSAB1 Sabbath Mode Product Kit

(available at
extra cost)



COMPLIANT
(with kit installed
and icemaker OFF)

The Sabbath Mode Product Kit was designed for use on the Jewish Sabbath and Holidays. The Sabbath Mode feature makes it possible for observant Jews to refrigerate and freeze food during the duration of the holiday.

The Sabbath Mode feature can be set to override typical reactions to actions in your refrigerator. While in the Sabbath Mode, your refrigerator will still operate normally. However, the refrigerator will not respond to your actions.

While in the Sabbath Mode, you may notice the fan running when the door is opened; however, this is not a result of your actions. The fan will operate at random times. The defrost heater will continue to defrost the refrigerator and freezer and will be activated on a timer. The defrost heater will not defrost as a result of door openings or any consumer actions.

ON/OFF—To activate, raise the top grillepanel and set the Sabbath Mode switch to the **ON** position. A green LED light will be visible below the Sabbath Mode Kit switch. The light will be visible when the grille is closed between the grille door and compartment doors.

DISPLAYS, ALARMS and LIGHTS—The main temperature control displays will be deactivated; therefore they will not be lit, sound a tone or operate when touched. Door alarms and lights will be disabled.

ICEMAKER—The icemaker will continue to operate. The icemaker can be disabled by setting the icemaker power switch to the **OFF** position (see Automatic Icemaker). To obtain ice, open the freezer door and remove the cubed ice from the ice bin.

This Sabbath Mode Product Kit can be purchased from your local appliance dealer. The ZSAB1 Kit is designed for use with all Monogram Built-In All-Refrigerators and All-Freezers manufactured after 2008. To locate your nearest dealer, visit our web site monogram.com or call 1.800.626.2005. In Canada, call 1.800.561.3344. Order Kit # ZSAB1.

NOTE: The Sabbath Mode Product Kit must be installed by a qualified service technician.

NOTE: If installing the refrigerator and freezer as a pair, 2 Sabbath Mode Kits must be ordered.

Cleaning outside

Door handles and trim—Clean with a cloth dampened with soapy water. Dry with a soft cloth.

Keep the outside clean. Wipe with a clean cloth lightly dampened with mild liquid dish detergent. Dry with a clean, soft cloth.

Do not wipe the refrigerator/freezer with a soiled dish cloth or wet towel. These may leave a residue that can damage the finish. Do not use scouring pads, powdered cleaners, bleach or cleaners containing bleach because these products can scratch and damage the finish.

Stainless steel—Regularly clean and polish the stainless steel door panels and handles (on some models) with a commercially available stainless steel cleaner such as *Stainless Steel Magic™* to preserve and protect the fine finish. *Stainless Steel Magic* and the Monogram polishing cloth are available through GE Appliances Parts and Accessories, 877.959.8688, or monogram.com. For *Stainless Steel Magic*, order part number WX10X15. For Monogram polishing cloth, order part number WX72X10001.

Do not use appliance wax or polish on the stainless steel.

Cleaning inside

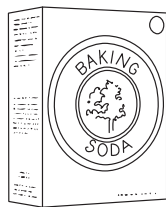

To help prevent odors, leave an open box of baking soda in the refrigerator/freezer.

Turn off power at the circuit breaker or fuse box before cleaning. If this is not practical,

wring excess moisture out of sponge or cloth when cleaning around switches, lights or controls.

Use warm water and baking soda solution— about a tablespoon (15 ml) of baking soda to a quart (1 liter) of water. This both cleans and neutralizes odors. Thoroughly rinse and wipe dry.

Other parts of the refrigerator/freezer— including door gaskets, meat and vegetable drawers, ice storage bin and all plastic parts—can be cleaned the same way. After cleaning the door gaskets, apply a thin layer of petroleum jelly to the door gaskets sealing surface on the hinge side. This helps keep the gaskets from sticking and bending out of shape.

Avoid cleaning cold glass shelves with hot water because the extreme temperature difference may cause them to break. Handle glass shelves carefully. Rough handling of tempered glass can cause it to shatter.

Do not wash any plastic refrigerator/freezer parts in the dishwasher.

Preparing for vacation

For long vacations or absences, remove food from the refrigerator/freezer. Set the control to **OFF**, and clean the interior with a baking soda solution of one tablespoon (15 ml) of baking soda to one quart (1 liter) of water. Leave the door open.

For shorter vacations, remove perishable foods and leave the control at the regular setting. However, if the room temperature is expected to drop below 60°F (16°C), follow the same instructions as for extended vacations.

Move icemaker power switch to the **OFF** position and shut off the water supply to the freezer.

Using the master light switch

This feature turns off the lights inside the unit. The switch is located behind the top access panel. Lift up the panel to access the switch. Turning off the master switch does not turn off all power to the unit.

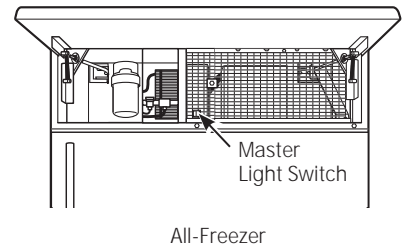
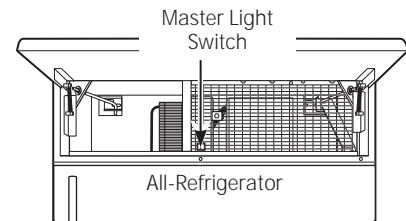

Light bulb replacement

For upper and lower light bulb replacement, call for service.

*Refrigerator/
freezer
location*

Do not install the refrigerator/freezer where temperatures will be below 60°F (16°C) because it will not run often enough to maintain proper temperatures, and the refrigerator will develop high internal humidity.

For proper installation, the refrigerator/freezer must be placed on a level surface of hard material the same height as the rest of the flooring. This surface should be strong enough to support a fully loaded refrigerator/freezer, or approximately 1,200 lbs. each. See the Installation Instructions for complete directions.

*Questions?
Use this
problem
solver!*

PROBLEM	POSSIBLE CAUSE
REFRIGERATOR/ FREEZER DOES NOT OPERATE	<ul style="list-style-type: none"> • May be in defrost cycle when motor does not operate for about 45 minutes. • Temperature control in the OFF position. • If interior light is not on, refrigerator/freezer may not be plugged in at wall outlet. • The house fuse is blown/house circuit breaker is tripped. Replace fuse or reset the breaker. • The Sabbath Mode Kit may be installed and operating. Turn off the Sabbath Mode device.
MOTOR OPERATES FOR LONG PERIODS OR CYCLES ON AND OFF FREQUENTLY (Modern refrigerators and freezers with more storage space and a larger freezer require more operating time. They start and stop often to maintain even temperatures.)	<ul style="list-style-type: none"> • Normal when refrigerator/freezer is first plugged in. Wait 24 hours or the refrigerator/freezer to completely cool down. • Often occurs when large amounts of food are placed in refrigerator/freezer. This is normal. • Door left open or package holding door open. • Hot weather or frequent door openings. This is normal. • Temperature control set at the coldest setting. See Temperature Control.
VIBRATION OR RATTLING (Slight vibration is normal.)	<ul style="list-style-type: none"> • Refrigerator may not be properly installed.
THUMPING SOUND WHEN DOOR IS CLOSED	<ul style="list-style-type: none"> • This is a normal operating sound. • The mechanism that closes the door makes a slight thumping sound as it passes over its lever point, at approximately 80 degrees. • Closing the door slowly will minimize the sound.
OPERATING SOUNDS	<ul style="list-style-type: none"> • The variable speed compressor changes speeds and sounds may vary. • Normal fan air flow—fans blow cold air through the fresh food and freezer compartments—another fan cools the compressor motor. • The fans change speeds in order to provide optimal cooling and energy savings. • These NORMAL sounds will also be heard from time to time: <ul style="list-style-type: none"> – You may hear a whooshing or gurgling sound when the door closes. This is due to pressure equalizing within the refrigerator. – A water dripping sound may occur during the defrost cycle as ice melts from the evaporator and flows into the drain pan. – The flow of refrigerant through the freezer cooling coils may make a gurgling sound like boiling water. – Water dropping on the defrost heater can cause a sizzling, popping or buzzing sound during the defrost cycle. – You may hear cracking or popping sounds when the refrigerator is first plugged in or during/after the defrost cycle. This happens as the refrigerator cools to the correct temperature. – The compressor may cause a clicking or chirping sound when attempting to restart (this could take up to 5 minutes). – The electronic control board may cause a clicking sound when relays activate to control refrigerator components. – Ice cubes dropping into the bin. – The icemaker water valve will buzz and water will run in tubes when the icemaker fills with water.

Questions?
Use this
problem
solver!
(cont.)

PROBLEM	POSSIBLE CAUSE
DOOR NOT CLOSING PROPERLY	<ul style="list-style-type: none"> • Package may be holding door open. • Check the door gasket; it may be out of position • Refrigerator is not level. See Installation Instructions.
REFRIGERATOR/FREEZER TOO WARM	<ul style="list-style-type: none"> • Temperature control not set cold enough. See Temperature Control. • Warm weather or frequent door openings. • Door left open for long time. • Package may be holding door open.
ACTUAL TEMPERATURE NOT EQUAL TO SET TEMPERATURE	<ul style="list-style-type: none"> • Refrigerator just plugged in. Allow 24 hours for system to stabilize. • Door open for too long. Allow 24 hours for system to stabilize. • Warm food added to refrigerator. Allow 24 hours for system to stabilize. • Defrost cycle is in process. Allow 24 hours for system to stabilize.
FROST OR ICE CRYSTALS ON FROZEN FOOD (Frost within package is normal.)	<ul style="list-style-type: none"> • Door left open or package holding door open. • Too frequent or too long door openings.
SLOW ICE CUBE FREEZING	<ul style="list-style-type: none"> • Door may have been left open. • Turn temperature control to a colder setting. • Package may be holding door open.
ICE CUBES HAVE ODOR/TASTE	<ul style="list-style-type: none"> • Old cubes need to be discarded. • Ice storage bin needs to be emptied and washed. • Unsealed packages in freezer may be transmitting odor/taste to ice cubes. • Interior of freezer needs cleaning. See Care and Cleaning. • Poor-tasting incoming water. Change the water filter.
AUTOMATIC ICEMAKER DOES NOT WORK	<ul style="list-style-type: none"> • Icemaker power switch is in the O (off) position. • Water supply turned off or not connected. • Freezer too warm. • Piled up cubes in storage bin may cause icemaker to shut off too soon. Level cubes by hand.
SMALL OR HOLLOW CUBES	<ul style="list-style-type: none"> • Water filter clogged. Replace the filter or use the filter bypass plug. • Check for a connection to a Reverse Osmosis water system. If an RO is connected, remove the water filter and install the original bypass plug that came with the unit.
MOISTURE FORMS ON OUTSIDE OF REFRIGERATOR/FREEZER	<ul style="list-style-type: none"> • Not unusual during periods of high humidity. Wipe surface dry. • Control humidity and temperature in the kitchen with air conditioning should eliminate this condition
MOISTURE COLLECTS INSIDE	<ul style="list-style-type: none"> • Too frequent or too long door openings. • In humid weather, air carries moisture into refrigerator/freezer when doors are opened. • Control humidity and temperature in the kitchen with air conditioning.
REFRIGERATOR/FREEZER HAS ODOR	<ul style="list-style-type: none"> • Foods with strong odors should be tightly covered. • Check for spoiled food. • Interior needs cleaning. See Care and Cleaning. • Defrost water system beneath unit needs cleaning. • Keep open box of baking soda in refrigerator/freezer; replace every 3 months.
INTERIOR LIGHT DOES NOT WORK	<ul style="list-style-type: none"> • No power at outlet. • Light bulb needs replacing. See Call for service. • Master light switch may be in the OFF position. Switch to ON. • The Sabbath Mode Kit may be installed and operating. Turn off Sabbath Mode device.
DOOR DIFFICULT TO REOPEN IMMEDIATELY AFTER CLOSING	<ul style="list-style-type: none"> • Tight door seal is due to pressure equalizing within the refrigerator. After closing the door, wait 5–30 seconds to reopen.

Performance Data Sheet

SmartWater™ Filtration System—GE MWF Cartridge

Performance Data Information

Capacity: 300 Gallons (1,135 Liters)

The concentration of the contaminants tested for this filter in water entering the system was reduced to a concentration less than or equal to the permissible limit for water leaving the system as specified in NSF/ANSI Standard 42 and Standard 53. System tested and certified by NSF International against NSF/ANSI Standard 42 and Standard 53.

Please see geappliances.com for complete listing of the contaminants tested and the amounts reduced

The following pharmaceutical reduction claims have not been certified by NSF International or the state of California. Claims tested and verified by independent laboratory:

Contaminant Reduction	Average Influent	NSF specified Challenge Concentration	Avg % Reduction	Average Product Water Concentration	Max Permissible Product Water Concentration	NSF Reduction Requirements	NSF Test Report
Atenolol	978 ng/L	N/A	99.5%	5.0 ng/L	N/A	N/A	J-00121587
Fluoxetine	907 ng/l	N/A	99.4%	5.4 ng/L	N/A	N/A	J-00121587
Ibuprofen	885 ng/L	N/A	94.1%	52.3 ng/L	N/A	N/A	J-00121588
Progesterone	1097 ng/L	N/A	99.5%	5.0 ng/L	N/A	N/A	J-00121589
Trimethoprim	415 ng/L	N/A	99.5%	2.0 ng/L	N/A	N/A	J-00121587

Application Guidelines/Water Supply Parameters

Service Flow	0.5 gpm (21.9 lpm)
Water Supply	Potable Water

Water Pressure	40-120 psi (2.8-8.2 bar)
Water Temperature	33°F-100°F (0.6°C-38°C)

It is essential that the manufacturer's recommended installation, maintenance and filter replacement requirements be carried out for the product to perform as advertised. See Installation Manual for Warranty information.

Note: While the testing was performed under standard laboratory conditions, actual performance may vary. Replacement Cartridge: MWF. For estimated costs of replacement elements please call 1-800-626-2002 or visit our website at www.geapplianceparts.com.

⚠ WARNING

To reduce the risk associated with ingestion of contaminants:

- **Do not use with water that is microbiologically unsafe or of unknown quality without adequate disinfection before and after the system.** Systems certified for cyst reduction may be used on disinfected water that may contain filterable cysts. EPA Establishment Number 10350-MN-005.

For conditions of use, health claims certified by the California Department of Public Health, and replacements, see performance data sheet. California Department of Public Health Certification #05-1698. The contaminants or other substances removed or reduced by this water filter are not necessarily in all users' water.

NOTICE

To reduce the risk associated with property damage due to water leakage:

- **Read and follow** use instructions before installation and use of this system.
- Installation and use **MUST** comply with all state and local plumbing codes.
- **Do not** install if water pressure exceeds 120 psi (8.2 bar). If your water pressure exceeds 80 psi, you **must** install a pressure-limiting valve. Contact a plumbing professional if you are uncertain how to check your water pressure.
- **Do not** install where water hammer conditions may occur. If water hammer conditions exist you **must** install a water hammer arrester. Contact a plumbing professional if you are uncertain how to check for this condition.
- **Do not** install on hot water supply lines. The maximum operating water temperature of this filter system is 100° F (38° C).
- **Protect filter from freezing.** Drain filter when temperatures drop below 33°F (0.6°C).
- The disposable filter cartridge **must** be replaced every **6** months at the rated capacity, or sooner if a noticeable reduction in flow rate occurs.



Tested and certified by NSF International against NSF/ANSI Standard 42 and Standard 53 in model GE MWF for the reduction of the claims specified on the performance data sheet.

With the purchase of your new Monogram appliance, receive the assurance that if you ever need information or assistance from GE Appliances, we'll be there. All you have to do is call!

***GE Appliances
Answer Center®***

***In the USA:
800.626.2005***

Whatever your question about any Monogram major appliance, GE Appliances Answer Center® information service is available to help. Your call—and your question—will be answered promptly and courteously. Call the GE Appliances Answer Center® Monday to Friday, 8 a.m. to 10 p.m. EST, and Saturday, 8 a.m. to 7 p.m.

OR

Visit our Website at: monogram.com

In Canada, call 1.800.561.3344.

***In-Home Repair
Service***

***In the USA:
800.432.2737***

***In Canada:
1.800.561.3344***

A GE Appliances consumer service professional will provide expert repair service, scheduled at a time that's convenient for you. To schedule service, call Monday to Friday, 7 a.m. to 10 p.m. EST, or Saturday and Sunday, 8 a.m. to 6 p.m. Many GE Appliances Consumer Service company-operated locations offer you service today or tomorrow, or at your convenience. Our factory-trained technicians know your appliance inside and out—so most repairs can be handled in just one visit.

In Canada: Monday to Friday, 7 a.m. to 8 p.m. and Saturday, 8 a.m. to 5 p.m. EDT.

***For Customers
With Special
Needs...***

***In the USA:
800.626.2005***

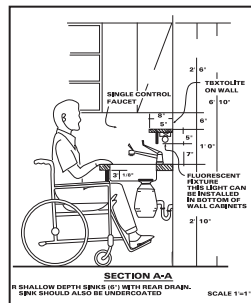

GE Appliances offers Braille controls for a variety of GE appliances, and a brochure to assist in planning a barrier-free kitchen for persons with limited mobility.

Consumers with impaired hearing or speech who have access to a TDD or a conventional teletypewriter may call 800.TDD.GEAC (800.833.4322) to request information or service.

***Service
Contracts***

***In the USA:
800.626.2224***

***In Canada:
1.800.290.9029***

You can have the secure feeling that GE Appliances Consumer Service will still be there after your warranty expires. Purchase a GE Appliances contract while your warranty is still in effect and you'll receive a substantial discount. With a multiple-year contract, you're assured of future service at today's prices.

***Parts and
Accessories***

***In the USA:
877.959.8688***

***In Canada:
1.800.561.3344***

Individuals qualified to service their own appliances can have parts or accessories sent directly to their home. The GE Appliances parts system provides access to over 47,000 parts...and all GE Appliances Genuine Renewal Parts are fully warranted. VISA, MasterCard and Discover cards are accepted. Visit www.geappliances.com.

User maintenance instructions contained in this manual cover procedures intended to be performed by any user. Other servicing generally should be referred to qualified service personnel. Caution must be exercised, since improper servicing may cause unsafe operation.

YOUR MONOGRAM REFRIGERATOR AND FREEZER WARRANTY
Staple sales slip or cancelled check here. Proof of original purchase date is needed to obtain service under warranty.

WHAT IS COVERED

From the Date of the Original Purchase

LIMITED TWO-YEAR WARRANTY

For two years from date of original purchase, we will provide, free of charge, parts and service labor in your home to repair or replace any part of the refrigerator or freezer that fails because of a manufacturing defect.

LIMITED FIVE-YEAR WARRANTY

For five years from date of original purchase, we will provide, free of charge, parts and service labor in your home to repair or replace any part of the sealed refrigerating system (the compressor, condenser, evaporator and all connecting tubing) that fails because of a manufacturing defect.

LIMITED ADDITIONAL SIXTH- THROUGH TWELFTH-YEAR WARRANTY ON THE SEALED SYSTEM

For the sixth through twelfth year from the date of the original purchase, we will provide, free of charge, replacement parts for any part of the sealed refrigerating system (the compressor, condenser, evaporator and all connecting tubing) that fails because of a manufacturing defect. You pay for the service trip to your home and for service labor charges.

LIMITED THIRTY-DAY WARRANTY ON WATER FILTER CARTRIDGE Appliances (Water filter, if included)

From the date of the original purchase we will provide, free of charge, replacement parts for any part of the water filter cartridge that fails because of a manufacturing defect. During this limited thirty-day warranty, we will also provide, free of charge, a replacement water filter cartridge.

.....

This warranty is extended to the original purchaser and any succeeding owner for products purchased for ordinary home use in the 48 mainland states, Hawaii, Washington, D.C. or Canada. If the product is located in an area where service by a GE Appliances Authorized Servicer is not available, you may be responsible for a trip charge or you may be required to bring the product to an Authorized GE Appliances Service location for service. In Alaska the warranty is the same except that it is LIMITED because you must pay to ship the product to the service shop or for the service technician's travel costs to your home.

All warranty service will be provided by our Factory Service Centers or by our authorized Customer Care® servicers during normal working hours.

Should your appliance need service, during warranty period or beyond, in the USA call 800.432.2737. In Canada: 800.561.3344. Please have your serial number and model number available when calling for service.

WHAT IS NOT COVERED

- Service trips to your home to teach you how to use the product.
- Replacement of house fuses or resetting of circuit breakers.
- Damage to the product caused by accident, fire, floods or acts of God.
- Failure of the product if it is used for other than its intended purpose or used commercially.
- Damage caused after delivery.
- Improper installation, delivery or maintenance. If you have an installation problem, contact your dealer or installer. You are responsible for providing adequate electrical, plumbing and other connecting facilities.
- Replacement of the light bulbs, if included, or water filter cartridge, if included, other than as noted above.
- Replacement of the water filter cartridge, if included, due to water pressure that is outside the specified operating range or due to excessive sediment in the water supply.
- Loss of food due to spoilage (in the USA only).
- Incidental or consequential damage caused by possible defects with this appliance.
- Product not accessible to provide required service.
- Damage caused by a non-GE Appliances brand water filter.

EXCLUSION OF IMPLIED WARRANTIES—Your sole and exclusive remedy is product repair as provided in this Limited Warranty. Any implied warranties, including the implied warranties of merchantability or fitness for a particular purpose, are limited to one year or the shortest period allowed by law.

Some states/provinces do not allow the exclusion or limitation of incidental or consequential damages, so the above limitation or exclusion may not apply to you. This warranty gives you specific legal rights, and you may also have other rights which vary from state to state/province to province. To know what your legal rights are in your state/province, consult your local or state/provincial consumer affairs office or your state's Attorney General.

224D2602P002
 49-60722-4

04-16 GE
 Printed in the United States

Warrantor in USA: GE Appliances,
 Louisville, KY 40225

Warrantor in Canada: Mabe Canada Inc.



GE APPLIANCES
 Appliance Park
 Louisville, KY 40225